

République Algérienne Démocratique et Populaire
Ministère de l'Enseignement Supérieur et de la Recherche Scientifique
ECOLE NATIONALE POLYTECHNIQUE



DÉPARTEMENT D'ÉLECTRONIQUE

Mémoire de Master

Thème :

**The influence of correlation on antenna
diversity**

Encadré par :

Pr. AKSAS Rabia

Réalisé par :

Mlle KROUKA Wafa

Promotion : Juin 2015

ملخص

على الرغم من تطور الاتصالات اللاسلكية، فإنها تعاني دائما من مشاكل تلاشي الإشارة الناجمة عن تعدد المسارات. في إطار مذكرتنا سنعرض نتائج استخدام التنوع الاستقطابي للهوائيات لإثبات كفاءتها في التقليل من مشاكل تلاشي الإشارة. حيث استخدمنا عدة أنظمة هوائيات تعتمد على التنوع الاستقطابي و قمنا بتقييمها بعد الحصول على البيانات الواردة باستخدام لوحة /اروينو و ماتلاب .

تم استخدام نوع اخر من التنوع الهوائي لدراسة تأثير الارتباط عليه. والمتمثل في التنوع المكاني للهوائيات، حيث تم محاكاة هيكل جديد و مقارنة معاملات النقل المختلفة والتي كانت نتيجة للمحاكاة، وذلك بدلالة المسافة التي تفصل بين الهوائيين.

كلمات المفاتيح: تنوع الهوائيات، الاستقطاب، المسارات المتعدد، الارتباط، اقتران.

Résumé

Les communications sans fils ont connu une évolution significative, bien qu'ils souffrent toujours des problèmes d'évanouissement.

Dans le cadre de notre travail, Les résultats d'évaluation de la diversité d'antenne en polarisation ont été exposés, afin de vérifier l'efficacité de la diversité en polarisation. Différents systèmes d'antennes en réception ont été évalués après une acquisition de données à l'aide de la carte Arduino et Matlab.

Un deuxième type de diversité a été utilisé pour étudier l'influence de la corrélation sur la diversité d'antenne. Une nouvelle structure basée sur la diversité spatiale a été simulée pour différentes valeurs de la distance séparant ses éléments constitutifs.

Une comparaison a été effectuée entre les différents coefficients de transmission de la structure simulée en fonction de la distance séparant ses éléments.

Mots clés : Diversité, polarisation, diversité spatiale, corrélation, couplage.

Abstract

Despite the evolution of wireless communications, it always suffers from signal fading problems caused by multipath. In our work, results of using antenna polarization diversity have been exposed to prove its efficiency in combating fading problems. Different receive antenna systems based on polarization diversity have been used to be evaluated after a received data acquisition using Arduino board and Matab.

A second type of antenna diversity have been used to study the influence of correlation on antenna diversity. Based on antenna spatial diversity, a new structure have been simulated for different distances separating its constituent elements. A comparison has been done between different transmission coefficients of the simulated structure as a function of the separating distance.

Key words : Diversity, polarization, spatial diversity, correlation, mutual coupling.

Dedication

I dedicate this thesis to my loving parents .

To my dear brothers Monsef and Adel.

To my amazing sister Sihem and the little baby Yanis.

To all my friends and colleagues.

Acknowledgments

I thank god for helping me to accomplish this humble work.
I would like first to thank my advisor, Pr. Rabia AKSAS for his support and guidance.
I would like also to thank my thesis committee members TRABELSI Mohammed, and
M.BELOUHRANI Adel for accepting to be part of it.
All teachers of Ecole Nationale Polytechnique, and particularly Electronics department.
THANK YOU.

Contents

Introduction	8
1 Antenna diversity evaluation	9
1.1 Introduction	9
1.2 Antenna diversity	9
1.3 Diversity evaluation	11
1.4 Conclusion	13
2 The influence of correlation on antenna diversity	15
2.1 Introduction	15
2.2 Correlation	15
2.3 Spatial correlation	16
2.3.1 Correlation coefficient	17
2.4 Antenna mutual coupling	18
2.4.1 Influence of correlation on antenna spatial diversity	19
2.5 Conclusion	23
Conclusion	24
Bibliography	25
Appendices	26

List of abbreviations

MIMO	Multiple Input Multiple Output.
SIMO	Single Input Multiple Output.
MISO	Multiple Input Single Output.
SISO	Single Input Single Output.
SNR	Signal to Noise Ratio.
CST	Computer Simulation Technologie.

List of Symbols

λ	wave length	(m)
ρ_e	envelope correlation coefficient	
ρ_c	complex correlation coefficient	
ρ_p	power correlation coefficient	
h_{ij}	channels response	
S_{ii}	reflexion coefficients at access i	dB
S_{ij}	transmission coefficients from j to i	dB

List of Figures

1.1	Different antenna diversity types [1].	10
1.2	Wireless communication architectures [4].	10
1.3	Horn antenna diversity system.	11
1.4	Wired dipole antenna diversity system.	12
1.5	Diversity evaluation process.	12
1.6	Diversity Matlab results.	13
2.1	MIMO system [7].	16
2.2	Spatial diversity system [7].	19
2.3	Simulation results for $d = \frac{3}{4}\lambda$	20
2.4	Simulation results for $d = \frac{\lambda}{4}$	21
2.5	Simulation results for $d = \frac{4}{3}\lambda$	22

List of Tables

2.1	Transmission coefficients as a function of distance " d ".	23
-----	--	----

Introduction

In the last years, mobile phones and wireless communications have known a significant evolution. However, transmissions suffer from different problems and mainly the problem of fading.

Signal fades are generally caused by either path loss or multipath interference. A problem that affects the quality of transmissions. Diversity receivers help combat fades by using two antennas or more to reduce the loss of signal and guaranty a better signal strength at reception.

The first chapter of our thesis is dedicated to antenna polarization diversity, where we will present the results of evaluating the diversity of different antenna systems (with polarization diversity).

In the second chapter, another type of diversity will be used. We will simulate with CST a structure based on spatial diversity and compare simulation results for different values of the distance separating the system's elements.

Finally, we will deduce the influence of correlation caused by mutual coupling on antenna diversity.

Chapter 1

Antenna diversity evaluation

1.1 Introduction

In the new generation of mobile communication systems, high data transmission rate and high performance of the mobile terminals are needed.

However, wireless communication systems depends highly on the propagation environment properties. With has undesirable effects on the transmitted signal (multipath), leading to fading problems.

Antenna diversity techniques have been adopted as a solution, exploiting multipath in order to improve system performance.

The results of our final project concerning diversity evaluation are presented in this chapter.

1.2 Antenna diversity

The concept of diversity, that is, providing the receiver with multiple copies of the same message, is widely known to be effective in combating multipath fading; witch is a result of a number of delayed versions of the transmitted signal arriving at the receiver due to reflection from various structures.

There are several types of antenna diversity techniques (fig 1.1) that have been already discussed in our final project [8].

- Spatial diversity.
- Polarization diversity.
- Diagram diversity.

Many studies ([2],[3]) have been proving that polarization diversity presents some advantages relatively to other techniques when used for mobile terminals (small size equipments) since it provides better compactness and lower correlation coefficient.

The figure (1.1) illustrates some examples of antenna systems presenting different diversity techniques.

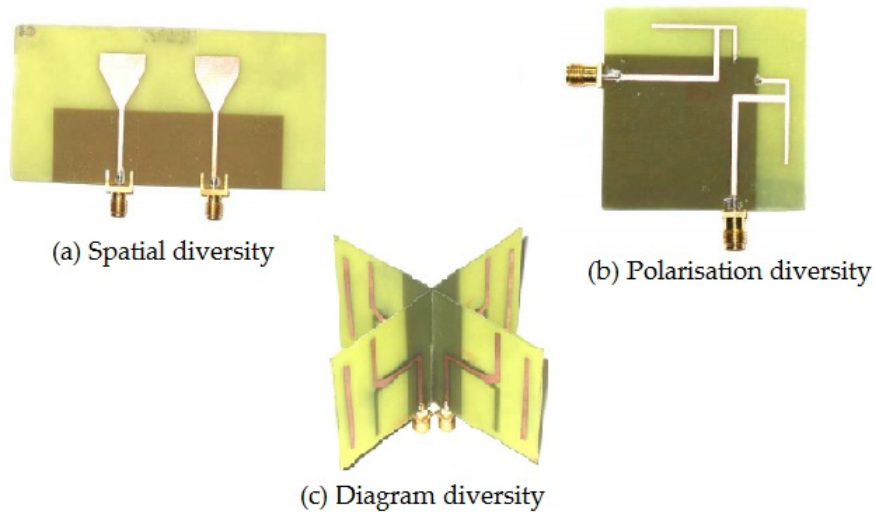

Figure 1.1: Different antenna diversity types [1].

In Wireless communication systems, there are different architectures based on multiple transmit and receive antennas. MIMO (Multiple Input Multiple Output) architecture (fig 1.2.d) is based on multiple antennas at both the transmitter and the receiver. It provides faster data transmission for longer distances compared to SISO (Single Input Single Output) architecture illustrated in figure 1.2.a.

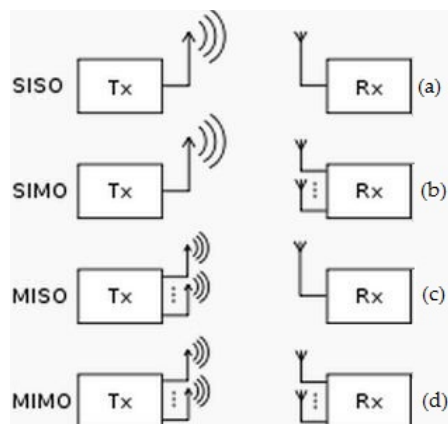

Figure 1.2: Wireless communication architectures [4].

The evaluation of antenna diversity relies on a very important parameter called "Diversity Gain".

This parameter is the main characteristic of a diversity system. It is defined as the improvement made to the channel in terms of SNR [1].

In the other hand, there are two key parameters that guaranty a good diversity gain: signal power equilibrium between different receivers and good correlation coefficient that we will be discussing in the next chapter.

1.3 Diversity evaluation

We have been exposing in our final project the improvement made to a wireless link (transmission) when using antenna diversity [8].

Based on polarization antenna diversity, we evaluated the performance of two different diversity systems (receivers).

The adopted systems consist of two linearly polarized antennas with orthogonal polarizations (vertical and horizontal).

The two antenna systems that have been evaluated are:

- Horn antenna system.
- Wired dipole antenna system.

A whole process has been implemented to evaluate the adopted diversity systems (fig 1.5).

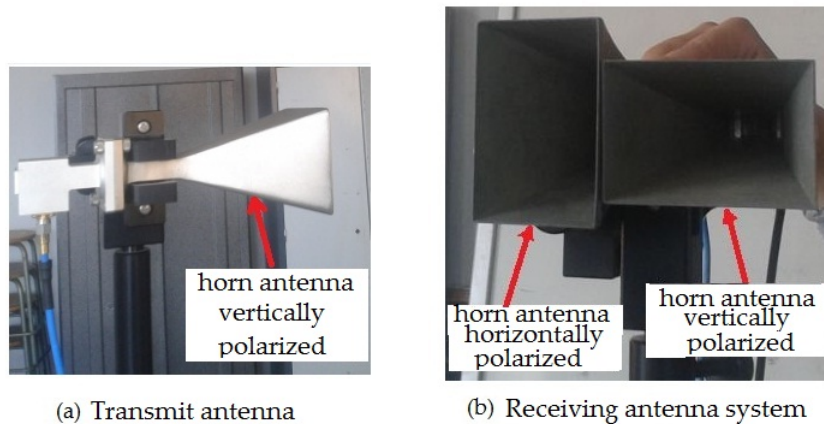

Figure 1.3: Horn antenna diversity system.

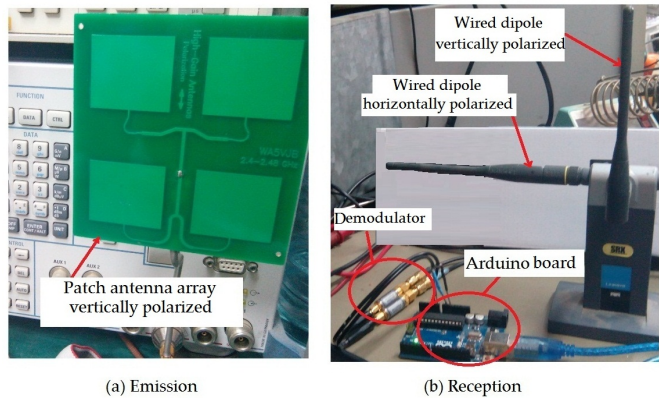

Figure 1.4: Wired dipole antenna diversity system.

- The evaluation process is summarized in the following steps:
- a/ Emission.
 - b/ Reception.
 - c/ Data acquisition and selection.
 - d/ Results display.

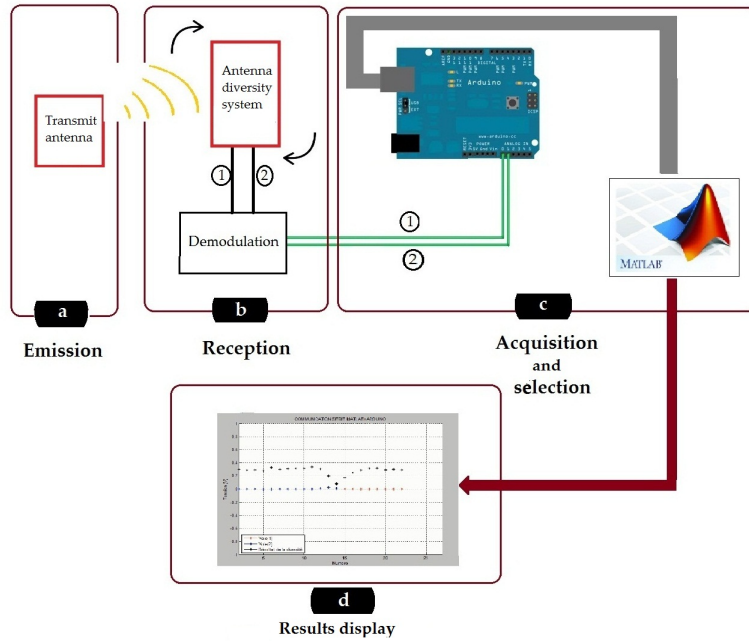
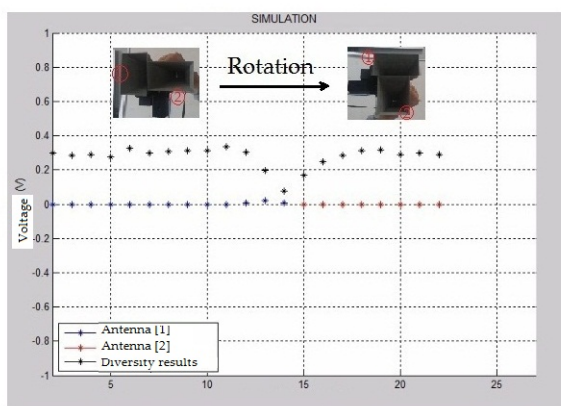

Figure 1.5: Diversity evaluation process.

After demodulation, the received signals are connected to the analog inputs of the Arduino board. To process the received data, Arduino is interfaced with Matlab to execute signals selection and plot diversity results.

The codes used for Analog data read on Arduino, executing the selection and results display on Matlab are attached as appendices (A) and (B) respectively.

Diversity results have been very satisfying. We proved that polarization diversity with selection technique, have improved the received signal level compared to a single receive antenna. Matlab results are illustrated in figure 1.6.



(a) Horn antennas at 10 GHz

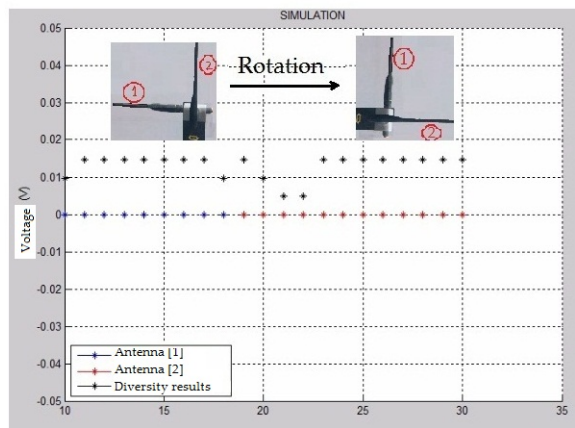

(b) Wired dipole antennas at 2.4 GHz

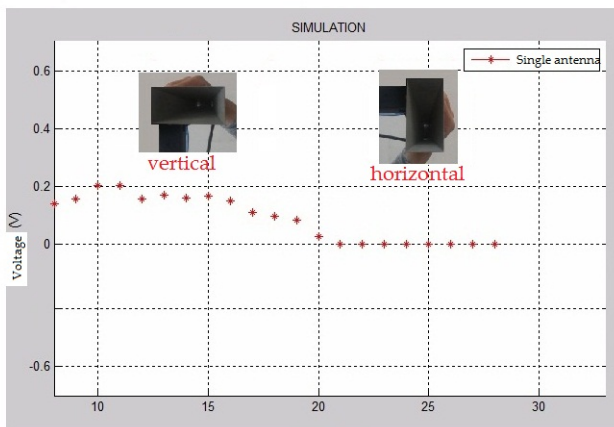

(c) Single antenna (no diversity)

Figure 1.6: Diversity Matlab results.

1.4 Conclusion

The positive results of the evaluation process reinforced the choice of diversity as a solution for multipath and so fading problem.

Polarization diversity technique have proven its efficiency improving wireless links (better reception). This type of diversity is mostly used for mobile terminals.

Spatial diversity is another type of diversity that is also widely used (MIMO). In this type of diversity, the distance separating the antennas is carefully chosen, so that minimum correlation is introduced.

In the next chapter we will be considering the influence of this distance and so correlation on antenna diversity.

Chapter 2

The influence of correlation on antenna diversity

2.1 Introduction

The performance of wireless communication systems can be improved by having multiple antennas either at the transmitter or the receiver or even both (antenna diversity).

The idea is that if the propagation channels between each pair of transmitting and receiving antennas are statistically independent and identically distributed this will increase the reliability of the transmission. In other words, it does not only depend on the number of channels, but also on the correlation between them. The less the channels are correlated the better is diversity gain.

Correlation between different pairs of transmitting and receiving antennas is related to the distance separating the elements of the two systems (in case of spatial diversity). This distance must be carefully chosen to introduce the minimum correlation. In this chapter we will simulate a spatial diversity based system, for different values of the distance separating its constituent elements.

2.2 Correlation

Correlation between transmitted signals is a measure of similarity or likeness between them. In the extreme case that if the signals are fully correlated, then the diversity system (MIMO) will have no difference from a single-antenna communication system (SISO).

In wireless communication systems, transmitted or received signals are often correlated. This correlation is mainly due to two components

- a/ Spatial correlation.
- b/ Antenna mutual coupling.

In the next sections we will detail the two previous points, with an emphasize on the correlation coefficient.

2.3 Spatial correlation

In a practical multipath wireless communication environment, the wireless channels are not independent from each other but due to scatterings in the propagation paths, the channels are related to each other with different degrees [5].

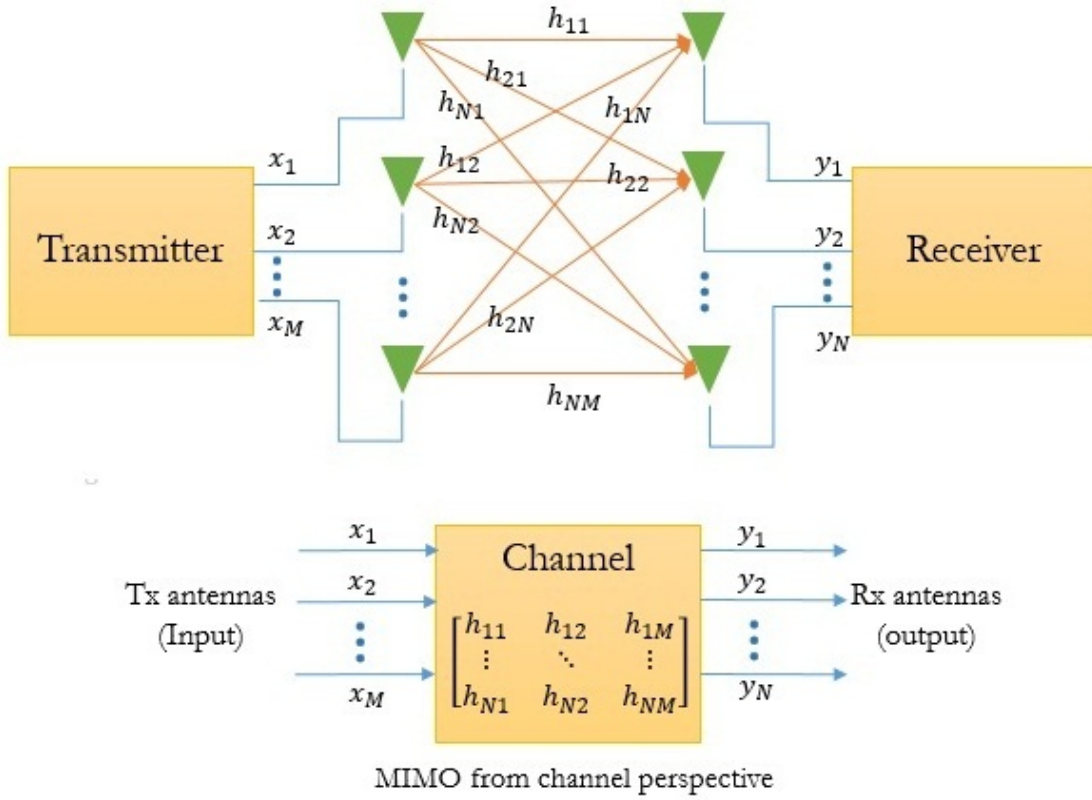

Figure 2.1: MIMO system [7].

Spatial correlation is often said to degrade the performance of multi antenna systems and put a limit on the number of antennas that can be effectively squeezed into a small device (as a mobile phone).

The spatial correlation between channels for a given channel matrix H is defined in the equation 2.1, with the entries $h_{ij}(h_{pq})$ corresponding to the response of the $i^{th}(p^{th})$ receiver to the signal sent by the $j^{th}(q^{th})$ transmitter respectively.

$$\rho_{ij,pq} = \frac{E[h_{ij}h_{pq}^*]}{\sqrt{E[h_{ij}h_{ij}^*]E[h_{pq}h_{pq}^*]}} \quad (2.1)$$

with: $i, p = 1, 2, \dots, N$. and: $j, q = 1, 2, \dots, M$.

As it has been already mentioned in the previous sections, a necessary condition that guaranties good diversity is the independence of the received signals. A condition verified once small correlation coefficient is obtained.

2.3.1 Correlation coefficient

Correlation coefficient is a mathematical and statistical tool that measures the likeliness and similarity between different signals received by antennas.

A good diversity is verified when there is low and ideally null correlation coefficient between different channels.

With a modulus varying from 0 to 1, most researches and work done in this subject consider that a correlation coefficient less than 0.7 provides a sufficient diversity [1].

Correlation coefficient have being defined with multiple notations. To avoid any confusion, we will consider three definitions of correlation coefficient

a/ Complex Correlation [1]

Knowing only the antennas properties and their propagation environment, complex correlation is an expression that, allows us to have information about the received signals correlation.

Initially defined by equation 2.1 in time domain, complex correlation is based on signals amplitude and phase

$$\rho_{1,2} = \frac{\int_0^T (v_1(t) - \bar{v}_1)(v_2(t) - \bar{v}_2)^* dt}{\sqrt{\int_0^T |v_1(t) - \bar{v}_1|^2 dt \cdot \int_0^T |v_2(t) - \bar{v}_2|^2 dt}} \quad (2.2)$$

Where

$|v_1(t)|, |v_2(t)|$ represent the received signals amplitudes.

\bar{v}_1, \bar{v}_2 represent the average of received signals respectively.

T represents the period of time in witch fading is being studied.

b/ Envelope Correlation [1]

Envelope correlation allows us to define the correlation between signals (amplitudes) but not their phase, it is presented by the equation 2.3 mentioned below

$$\rho_e = \frac{\int_0^T (\sqrt{s_1^2(t)} - \sqrt{\bar{s}_1^2})(\sqrt{s_2^2(t)} - \sqrt{\bar{s}_2^2})}{\sqrt{\int_0^T (\sqrt{s_1^2(t)} - \sqrt{\bar{s}_1^2})^2 dt \cdot \int_0^T (\sqrt{s_2^2(t)} - \sqrt{\bar{s}_2^2})^2 dt}} \quad (2.3)$$

Where $s_1^2(t)$, $s_2^2(t)$ represent the squared envelope of v_1, v_2 .

If we consider an incident uniform field, envelope correlation can be define as

$$\rho_e = |\rho_c|^2 = \frac{|S_{11}^* S_{12} + S_{21}^* S_{22}|^2}{(1 - (|S_{11}|^2 + |S_{21}|^2)) \cdot (1 - (|S_{22}|^2 + |S_{12}|^2))} \quad (2.4)$$

c/ Power Correlation [1]

Power correlation is directly related to envelope correlation, it's expressed in equation 2.5 as follows

$$\rho_p = \frac{\int_0^T (s_1^2(t) - \bar{s}_1^2)(s_2^2(t) - \bar{s}_2^2) dt}{\sqrt{\int_0^T (s_1^2(t) - \bar{s}_1^2)^2 dt \cdot \int_0^T (s_2^2(t) - \bar{s}_2^2)^2 dt}} \quad (2.5)$$

If we consider the signals s_1 and s_2 as vectors S_1 and S_2 and that their average is null, so their power correlation will be define in the equation 2.6 as

$$\rho_p = \frac{E[S_1 S_2]}{\sqrt{E[S_1 S_1] \cdot E[S_1 S_2]}} \quad (2.6)$$

2.4 Antenna mutual coupling

For diversity systems, except the spatial correlation will contribute to the channel correlation, antenna mutual coupling will also contribute [5].

Antenna mutual coupling describes energy absorbed by one antenna's receiver when another nearby antenna is operating. That is, mutual coupling is typically undesirable

because energy that should be radiated away is absorbed by a nearby antenna.

Similarly, energy that could have been captured by one antenna is instead absorbed by a nearby antenna.

Hence, mutual coupling reduces the antenna efficiency and performance of antennas in both the transmit and receive mode.

The antenna mutual coupling distorts the antenna radiation patterns and the input impedances, and therefore affects the correlation level and the efficiency which reduces diversity performance.

2.4.1 Influence of correlation on antenna spatial diversity

Diversity systems make use of multiple antennas at the ends of a communication link to exploit the spatial dimension for increasing the efficiency of the transmission.

In mobile terminals, we are always limited with the spatial dimension. The distance separating diversity system elements must be carefully chosen taking in consideration size limitations.

The figure 2.2 illustrates an antenna system, based on spatial diversity. We simulated the system using CST microwave studio software for different values of the distance " d " separating the two dipoles.

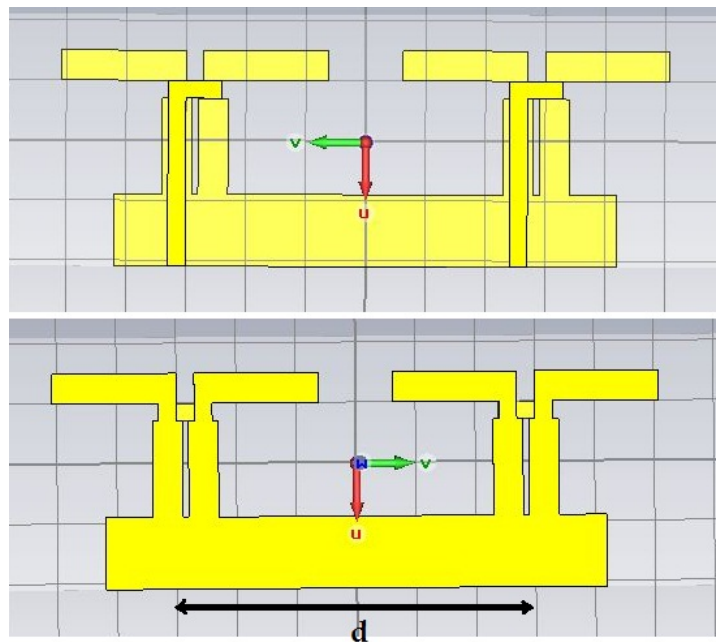

Figure 2.2: Spatial diversity system.

Mutual coupling and so correlation between the two dipoles are evaluated using transmission coefficients S_{12} and S_{21} .

We have been simulating the previous structure for three values of "d".

$$d = \frac{3}{4}\lambda = 57 \text{ mm.}$$

$$d = \lambda = 76 \text{ mm.}$$

$$d = \frac{4}{3}\lambda = 100 \text{ mm.}$$

Simulation results presented in figure 2.3 illustrate the reflexion and transmission coefficients of the antenna system for $d = \frac{3}{4}\lambda$.

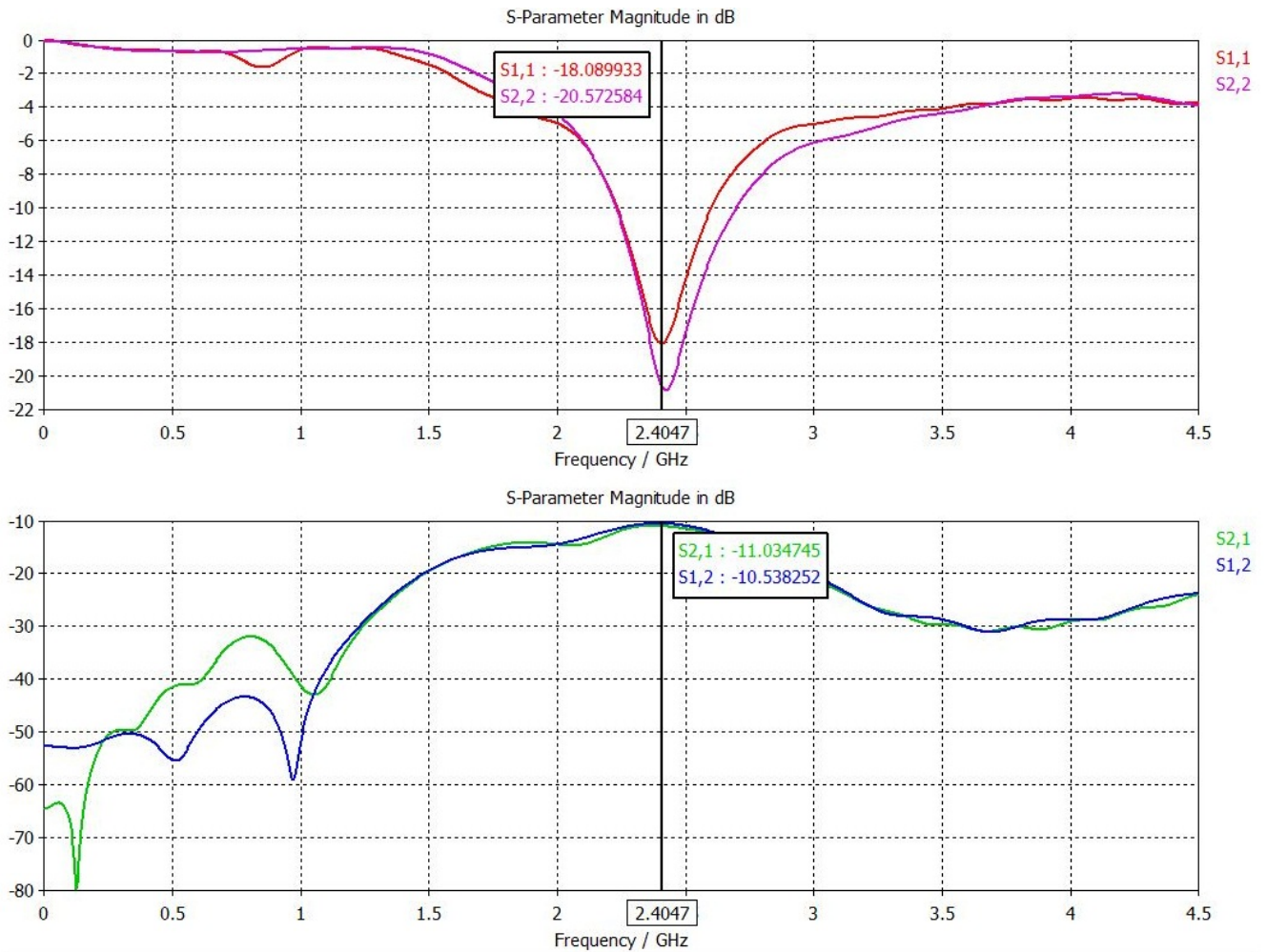

Figure 2.3: Simulation results for $d = \frac{3}{4}\lambda$.

Simulation results presented in figure 2.4 illustrate the reflexion and transmission coefficients of the antenna system for $d=\lambda$.

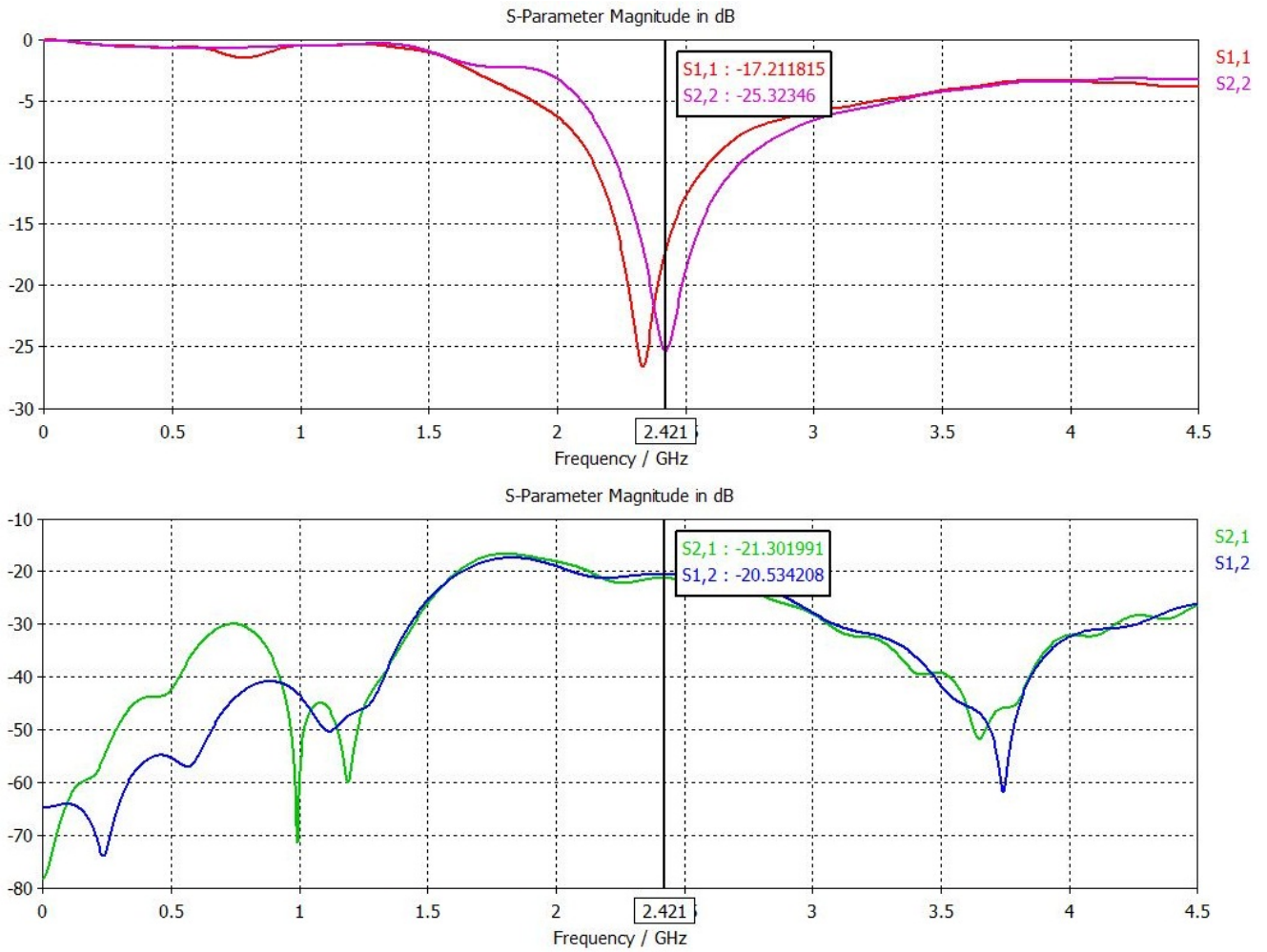

Figure 2.4: Simulation results for $d = \lambda$.

Simulation results presented in figure 2.5 illustrate the reflexion and transmission coefficients of the antenna system for $d=\frac{4}{3}\lambda$.

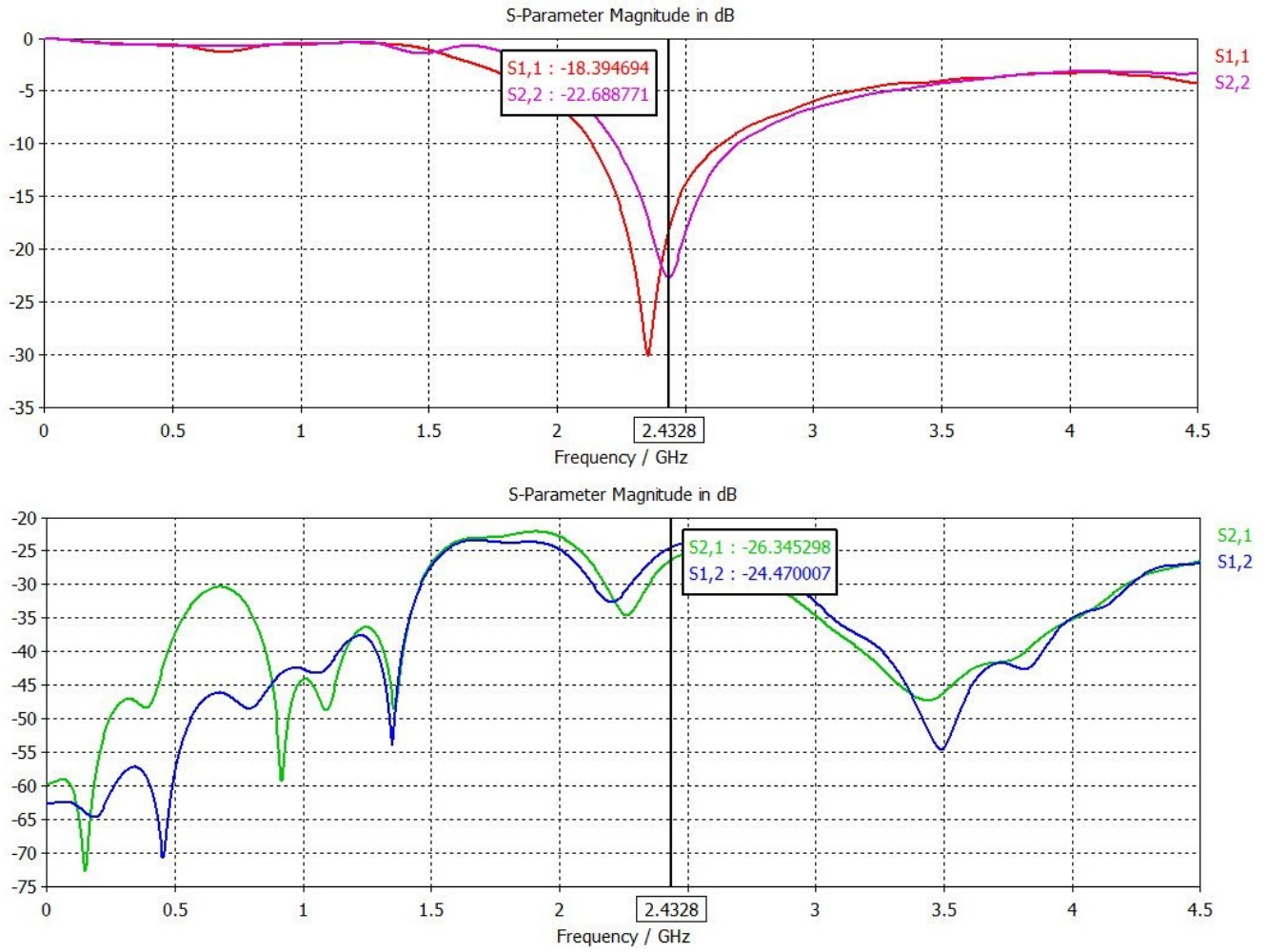

Figure 2.5: Simulation results for $d = \frac{4}{3}\lambda$.

Simulation results illustrate the relation between antenna mutual coupling and so antenna correlation and the distance separating the two elements of the system.

Resumed in table 2.1, we note that the smaller the distance separating the two dipoles (system's elements) the bigger S_{ij} are, and so, the more mutual coupling becomes important and the higher correlation is introduced.

To reduce and ideally avoid mutual coupling, the system's elements must be sufficiently separated. The thing that is limited by the spatial constraint especially when dedicated for mobile terminals.

The obtained results shows the indirect relation between the distance separating diversity system's elements and diversity. Better diversity is guaranteed when enough spacing is verified (low correlation).

Distance d	$\frac{3}{4}\lambda$	λ	$\frac{4}{3}\lambda$
$S_{12}(dB)$	-10.53	-20.53	-24.47
$S_{21}(dB)$	-11.03	-21.30	-26.34

Table 2.1: Transmission coefficients as a function of distance " d ".

2.5 Conclusion

A good diversity does not only depend on the number of diversity system elements, but also on the degree of independence between them.

One of the most important parameters that influence diversity is correlation between the antenna system elements.

The distance between different array elements is often limited with the spatial constraint, in the case of antenna arrays and particularly uniform linear arrays, it must be carefully chosen in order to verify low mutual coupling and so, low correlation level.

Conclusion

Signal fading had been considered as a harmful source to combat with transmit or receive diversity. We have adopted two types of diversity in our thesis.

Polarization diversity have been used in the first chapter to evaluate different receive systems. Using Arduino board and Matlab, we proved that the transmission has better performance when diversity is used.

A new structure based on two elements with spatial diversity has been simulated. We compared the different transmission coefficients obtained for different values of spacing between the elements.

Simulation results have proven that the larger the distance between the elements the lower correlation is introduced. Unfortunately, this spacing is limited with size constraint especially for small mobile terminals.

For future perspective, it is better to used a combination of two types of diversity to reduce mutual coupling and so correlation, in order to have better performance of the system.

Bibliography

- [1] E.Dreina, "Conception, optimisation et intégration RF d'un système d'antennes miniatures multicateurs utilisant la diversité en vue d'augmenter les performances radio d'un terminal mobile 4G", Thèse de Doctorat, Université de Grenoble, juillet 2010.
- [2] Bin Guo, "Antenna diversity in mobile phones ", Antenna group, department of signals and systems, CHALMERS UNIVERSITY OF TECHNOLOGY, Sweden, January,2008.
- [3] C.Tounou, "Contribution à l'étude de système à diversités d'antennes sur terminaux compactes. Mesure de performances en environnement réel", Thèse de Doctorat, Université de Limoges, Octobre 2008.
- [4] [http://fr.wikipedia.org/wiki/spatial correlation](http://fr.wikipedia.org/wiki/spatial_correlation)
- [5] Multiple Antennas for MIMO Communications - Channel Correlation , Notes by Prof. Hon Tat Hui.
- [6] <http://www.antenna-theory.com/definitions/mutualcoupling.php>
- [7] <http://www.gaussianwaves.com/2014/08/characterizing-a-mimo-channel>
- [8] W.Krouka, S.Fenni, "Evauation de la diversité d'antenne en polarisation", Projet de fin d'étude, Ecole Nationale Polytechnique, juin 2015.

Appendix A

Arduino code

```
int test1, test2;
int valeur1=0, valeur2=0;
//serial connexion
void setup() Serial.begin(115200);

void loop()
for(int i=0;i<100;i++)
//read the analog inputs
analogRead(A0);
analogRead(A1);
delay(10);

test1= analogRead(A0);
test2= analogRead(A1);
valeur1 = valeur1 + test1;
valeur2 = valeur2 + test2;

//calculate the average
valeur1 = valeur1 /100;
valeur2 = valeur2 /100;

Serial.println(valeur1);
delay(200) ;
Serial.println(valeur2);
delay(200) ;
```

Appendix B

Matlab code

```
function Matlab_Arduino_acquisition(numero)

close all;
clc;
y1=zeros(1,1000);
y2=zeros(1,1000);
y3=zeros(1,1000);
%initialisation du port serie
delete(instrfind({'Port'},{'COM10'}));
port_serie = serial('COM10');
port_serie.BaudRate=115200;
warning('off','MATLAB:serial:fscanf:unsuccessfulRead');

fopen(port_serie);
compteur=1;
figure('Name','Serial communication: Matlab + Arduino')
title('SIMULATION');
xlabel('Numero');
ylabel('Tension (V)');
grid on;
hold on;

while compteur <= numero
    ylim([-0.05 0.05]);
    xlim([compteur-20 compteur+5]);
    valeur1=fscanf(port_serie,'%d');
    valeur2=fscanf(port_serie,'%d');
```

```

        y1(compteur)=(valeur1(1))*5/1024;
        y2(compteur)=(valeur2(1))*5/1024;
        if y1(compteur)>=y2(compteur);
            y3(compteur)=y1(compteur);
        else y3(compteur)=y2(compteur);
        end
        plot(compteur,y1(compteur),'*-r');
        plot(compteur,y2(compteur),'*-b');
        plot(compteur,y3(compteur),'*-k');

legend('Voie[1]','Voie[2]','Résultat de la diversité'
        , 'Location','southwest');

drawnow
        compteur = compteur+1;
end

fclose(port_serie);
%fclose(arduino);
delete(port_serie);
clear all;
delete(instrfind({'Port'},{'COM10'}));
end

```